

VIEW	TOLERANCE	
	0-5	±0.1
	6-10	±0.25
	11-50	±0.5
UNIT: mm	51-100	±1
	101-250	±2
	251-500	±5
	501- >	±10

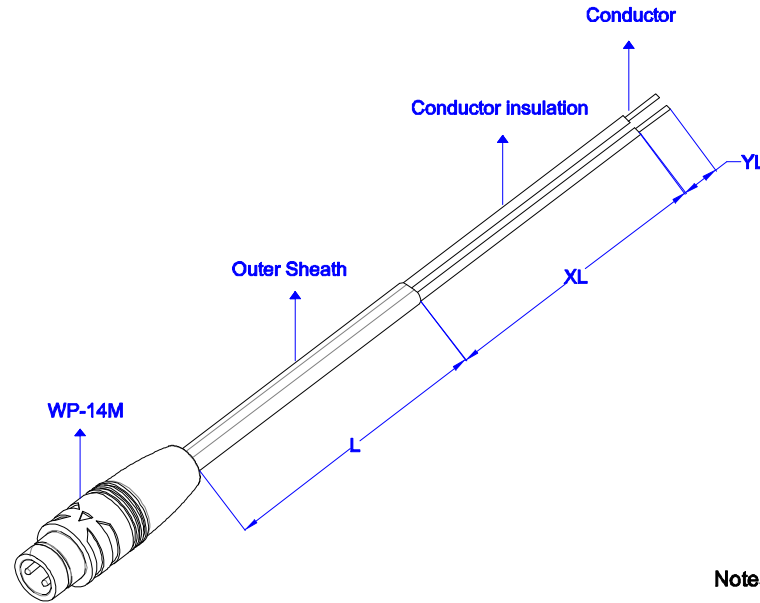

ORDER CODE:

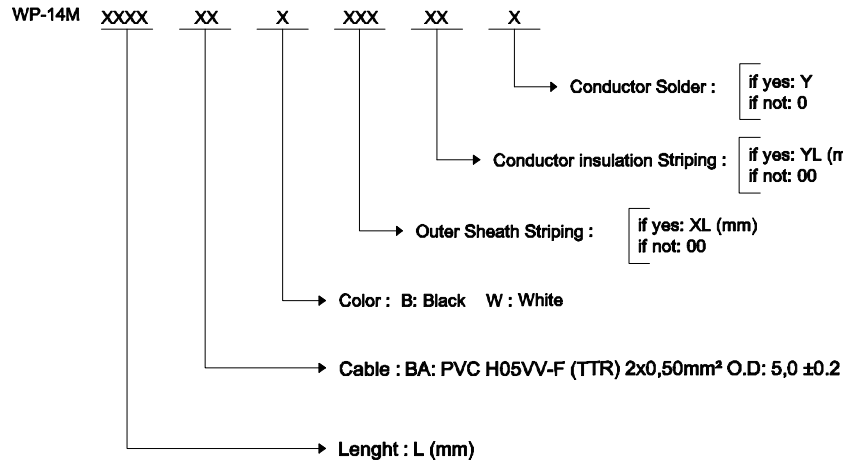

Notes:

Number Of Contact: 2 Pin
Contact: Brass Nickel Plated
Current Rating Percontact: 2A
Voltage Rating: 250V AC
Contact Resistance: <10M Ω
Insulation Resistance: 1000M Ω at DC 500V.
Breakdown Voltage: 1,5KV / 1 minute
Temperature Rating: -30C°~+70C°
Durability (Plug/Unplug): 3000 times
Waterproof Rating: IP67
Certificate: CE ; ROHS

4	-	PVC MOLDING / BLACK	-	-	-
3	-	2 PIN FEMALE CONNECTOR / BLACK	-	1	pc.
2	-	2 PIN MALE CONNECTOR / BLACK	-	1	pc.
1	KBL-9046	2x0.36mm ² CABLE / BLACK	-	-	-
No	Material Code	Description	Size (mm)	Q'ty	Unit
Date	16.12.2016	Rev.	Revision Detail		Rev.Dt. Rev.by
Designed by	Yegim AKSOY	-			
Checked by	Fatih BOLACA				
			WP-14M 2 Pin Seal Harness		
			Drawing Nr.	Scale	Sheet No
			-	NONE	1/2

VIEW	TOLERANCE	
	0-5	±0.1
	6-10	±0.25
	11-50	±0.5
UNIT: mm	51-100	±1
	101-250	±2
	251-500	±5
	501- >	±10

WP-14F

WP-14M

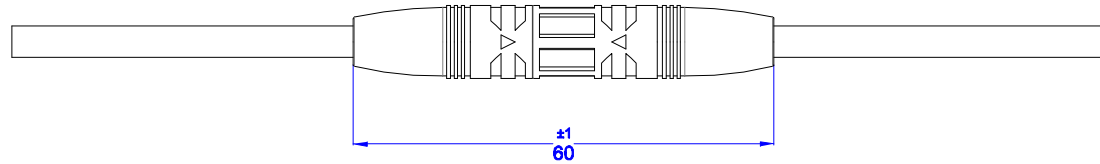
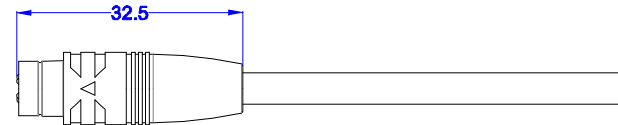
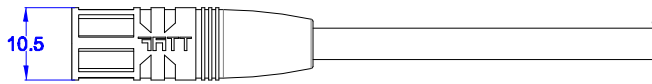
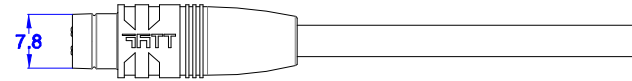
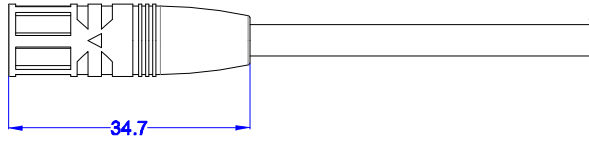

Date	01.12.2016	Rev.	-	Revision Detail		Rev.Dt.		Rev.by		Part No	WP-14F / WP-14M Connection Details				
Designed by	Yegim AKSOY	Checked by	Fatih BOLACA							Drawing Nr.	-	Scale	NONE	Sheet No	2/2
															

1

2

3

4

5

6

A4