

THIS DRAWING IS UNPUBLISHED.

RELEASED FOR PUBLICATION

© COPYRIGHT - By -

ALL RIGHTS RESERVED.

LOC

DIST

REVISIONS

変更

DESCRIPTION

DATE

DWN

APVD

J

-

P

LTR

E4 REVISED PER ECO-11-005140

07APR11

RK

HMR

注：  
△部分金めっき

NOTE：  
△SELECTIVE GOLD

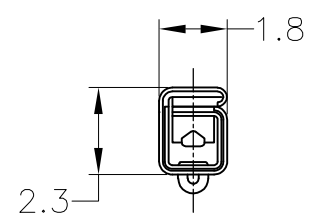
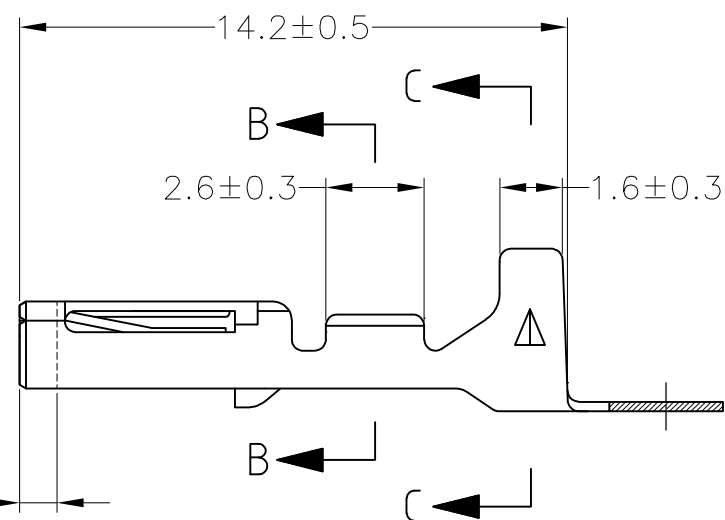
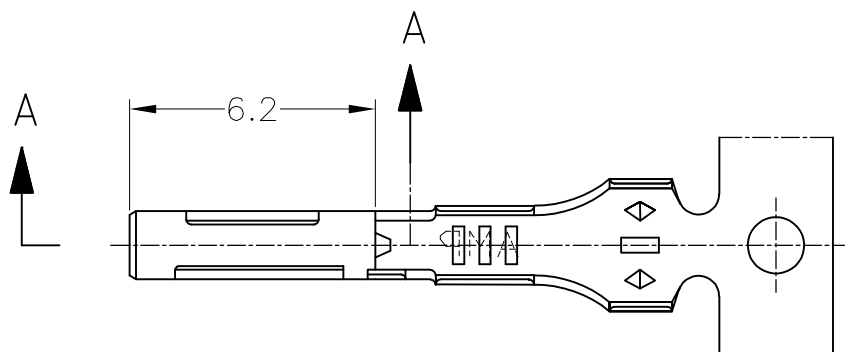

I.D. OF GOLD PLATED  
金めっき表示位置

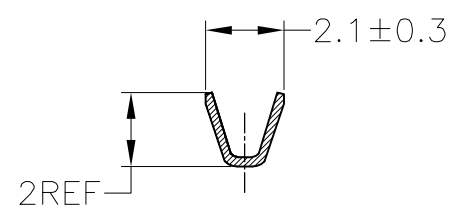

B-B

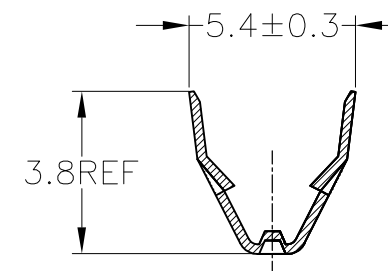

C-C

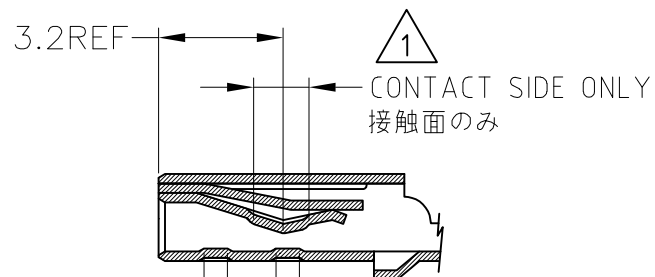

CONTACT SIDE ONLY  
接触面のみ

A-A

TOLERANCES UNLESS OTHERWISE SPECIFIED:

一般公差	
10 ≥	±0.2
30 ≥ > 10	±0.25
100 ≥ > 30	±0.3
ANGLE	±3°

THIS DRAWING IS A CONTROLLED DOCUMENT.

DIMENSIONS:  
単位： 耗  
mm

TOLERANCES UNLESS OTHERWISE SPECIFIED:  
一般公差

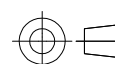

MATERIAL  
材料  
PHOS. BRONZE, THK 0.25  
りん青銅、板厚；0.25

FINISH  
仕上

SEE TABLE

DWN T.SHINOHARA 25MAY04

CHK K.BETSUI 25MAY04

APVD K.BETSUI 25MAY04

PRODUCT SPEC  
製品規格

APPLICATION SPEC  
取付適用規格

WEIGHT 0.262

CUSTOMER DRAWING

NAME

名称

SIZE

CAGE CODE

DRAWING NO  
番号

RESTRICTED TO

SCALE  
尺度

SHEET

REV

SEE DRAWING 173681-6	173681-6	
175062-2	SELECTIVE GOLD	173681-2
175062-1	PRE-TINNED	173681-1
LOOSE PIECES NUMBER	FINISH	PART NUMBER
WIRE RANGE (抱合電線断面積) 0.3~0.56mm <sup>2</sup> (AWG#22~20)		INSULATION DIA. (被覆外径) 1.8~2 mmφ

STE TE Connectivity

040 SERIES RECEPTACLE CONTACT

A3 00779 C-173681

SCALE 5:1 SHEET 1 OF 1 REV E4