

TOL. UNLESS SPECIAL SEE STANDARD TOLERANCE		Scale To Fit				
NOMINAL DIMENSION	0-30	30-100	100-200	200-400	400-1000	
0	± 0.1	± 0.2	± 0.3	± 0.5	± 1	
0.0	± 0.05	± 0.05	± 0.1	± 0.2	± 0.3	
0.00	± 0.01	± 0.02	± 0.05	± 0.05	± 0.1	

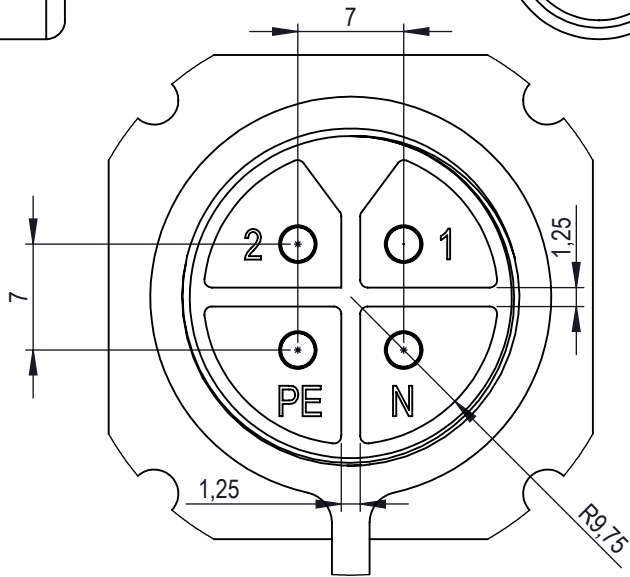
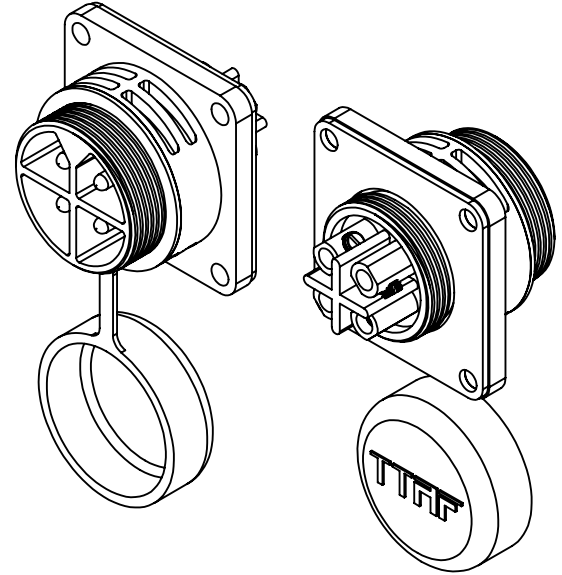
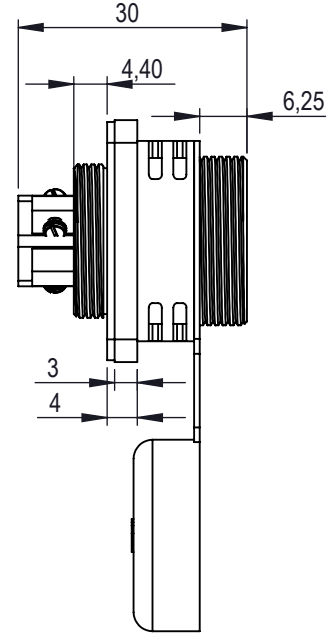
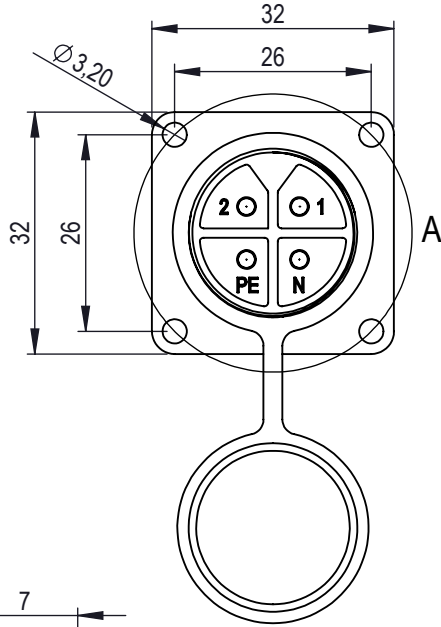
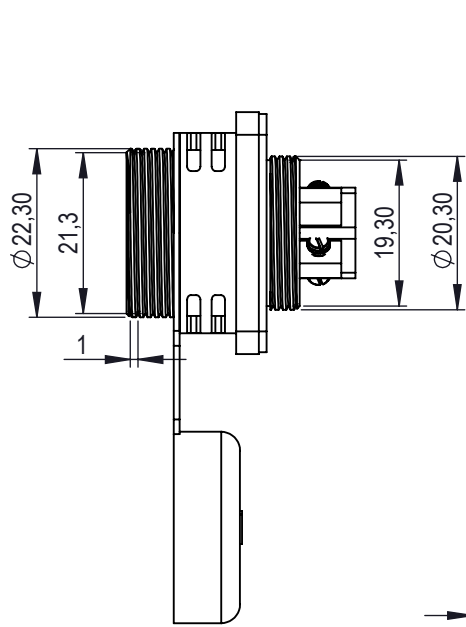

DETAIL A
scale 2 : 1

Technical Specifications

Number of Poles	4
Voltage Rating	250VAC max.
Current Rating	20A max.
Cable Cross Section Area	0,5 ~2,5mm ²
Durability Voltage	3000VAC@60s.
Insulation Structure	500 MΩ at 500VDC
Contact Resistance	30 mΩ max.
Min Wire Size OD	6mm
Max Wire Size OD	10mm
Operating Temperature	-40°C ~ +85°C
IP Rating	IP68(10m / 60min.)
Mold Material	PA6
Contact/Terminal Material	Nickel-Plated Brass
Seal Material	Silicone

Date	03.07.2018	Signature	Rev.	Revision Detail	Rev.Date	By	Drawing Description		
Drawn	Zafer BOLUKBASI		-		-	-	WPP-0400M20		
Checked	Dilek TUNCER								
Approved	Talat SAHIM								
							Drawing No	Scale	Sheet
							-	1:1	1/1

