

**TTAF
APPROVAL**

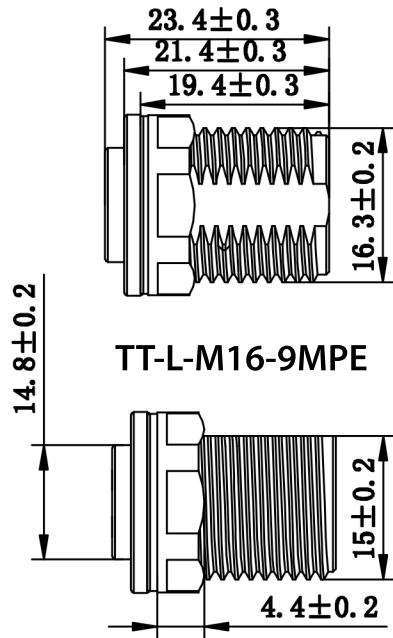

TT-L-M16-9MPE

M16-Male

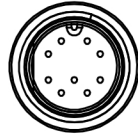

M16-Female

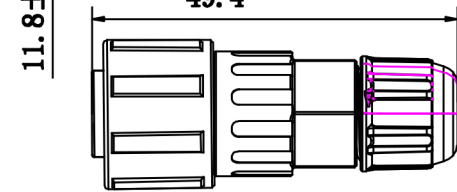
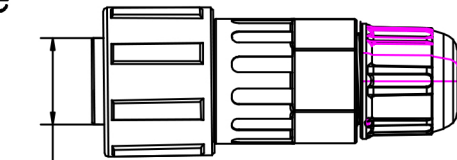
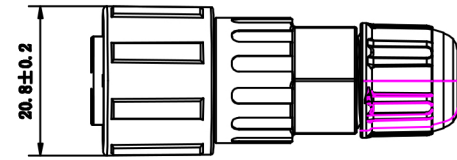
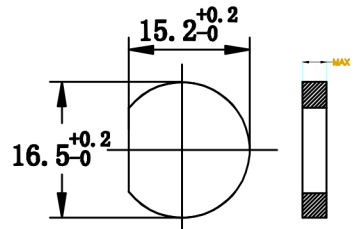
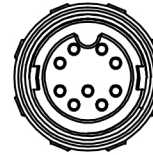

TT-L-M16-9FSX

Material:
 Connector:Nylon+GF
 Contact: Brass with Gold plated
Specification:
 Current Rating: 5A(φ0.8mm)
 Voltage Rating: 110V/AC
 Contact Resistance:<10mohm
 Insulation Resistance: 100Mohm at 300V/DC
 Breakdown Voltage:300V AC/1minute 2mA
 Temperature Rating: -40°C +105°C
 Waterproof rating: IP68
 Durability(Plug/Unplug): 2000times

Date	30.11.2016	Rev	Revision Detail	Rev.Dt	Rev.by	Part No		
Designed by	Yeşim AKSOY	-				TT-L-M16-9		
Checked by	Fatih BOLACA							
						Drawing Nr.	Scale	Sheet No
							NONE	1/1